

# RUFFLE CIRCLE BAG

WITH OPTIONAL ZIPPERED PURSE

30CM X 33CM | 12" X 13"



2  
green  
zebras

AUSTRALIAN DISTRIBUTOR

**LIBERTY.**  
FABRICS

# FABRIC REQUIREMENTS

## RUFFLE CIRCLE BAG SIZE 30cm x 33cm | 12" x 13"

Fabric SKU	Fabric SKU	Metric	Inches
------------	------------	--------	--------

### TO MAKE TOTE



036375478A or 036375478B

60CM WOF

23 5/8"

036375476A or 036375476C

40CM WOF

15 3/4"



Fusible interfacing or wadding 40cm x 90cm.

# CUTTING INSTRUCTIONS

Print and cut out the pattern template on page 4.

From the outer fabric cut:

- 2 25CM X 34CM rectangle pieces of outer fabric with the print pattern centred in the middle to fussy cut. Fold in half and place template on the fold to cut.
- 3 5" (12.7cm) strips for ruffles, to be sewn into one long piece
- 2 2" x 30" (5cm x 76.2cm) strips for handles (adjust to preferred length if needed).
- 1 3" x 20" strip for tie closure (optional)

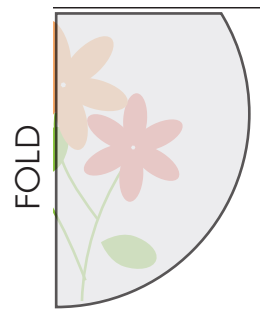
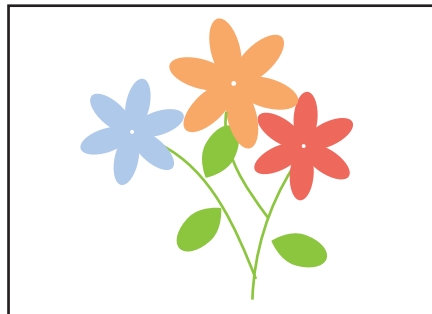

FUSSY CUT

SUGGESTED CUTTING LAYOUT FOR OUTER FABRIC

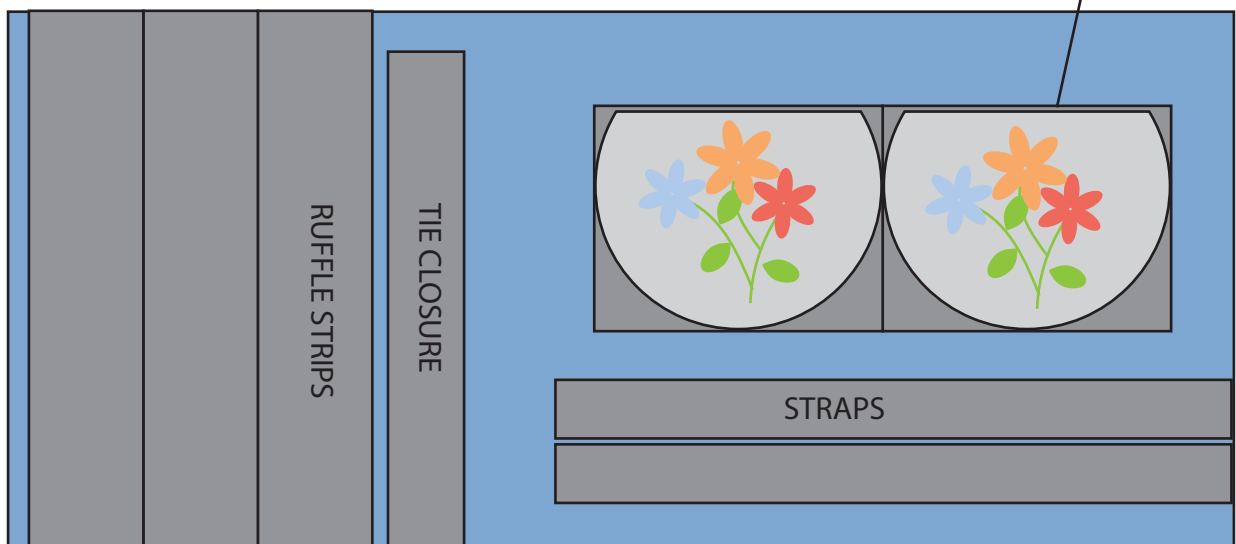

# CUTTING INSTRUCTIONS

## LINING

FOLD THE LINING FABRIC LENGTHWAYS AND CUT:

- 2 pieces for lining **cut on the fold**
- 2 2" x 30" strips for handles
- 2 5" x 12" ( 12.7cm x 30.5cm) rectangles for pockets

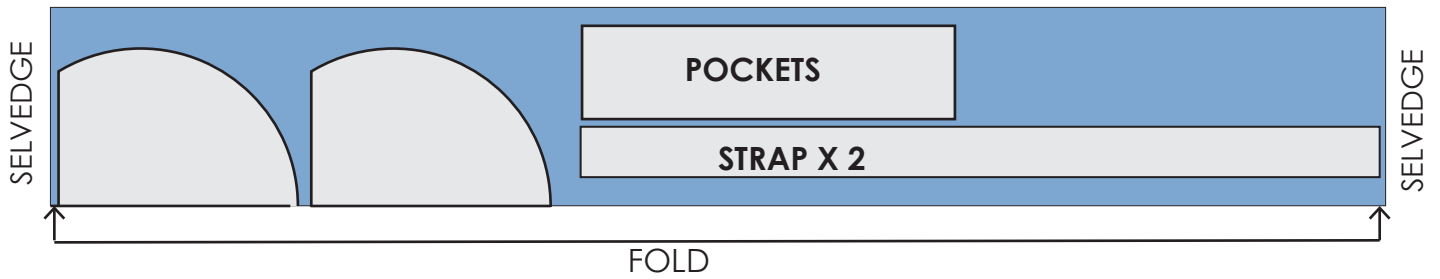

# PATTERN INSTRUCTIONS

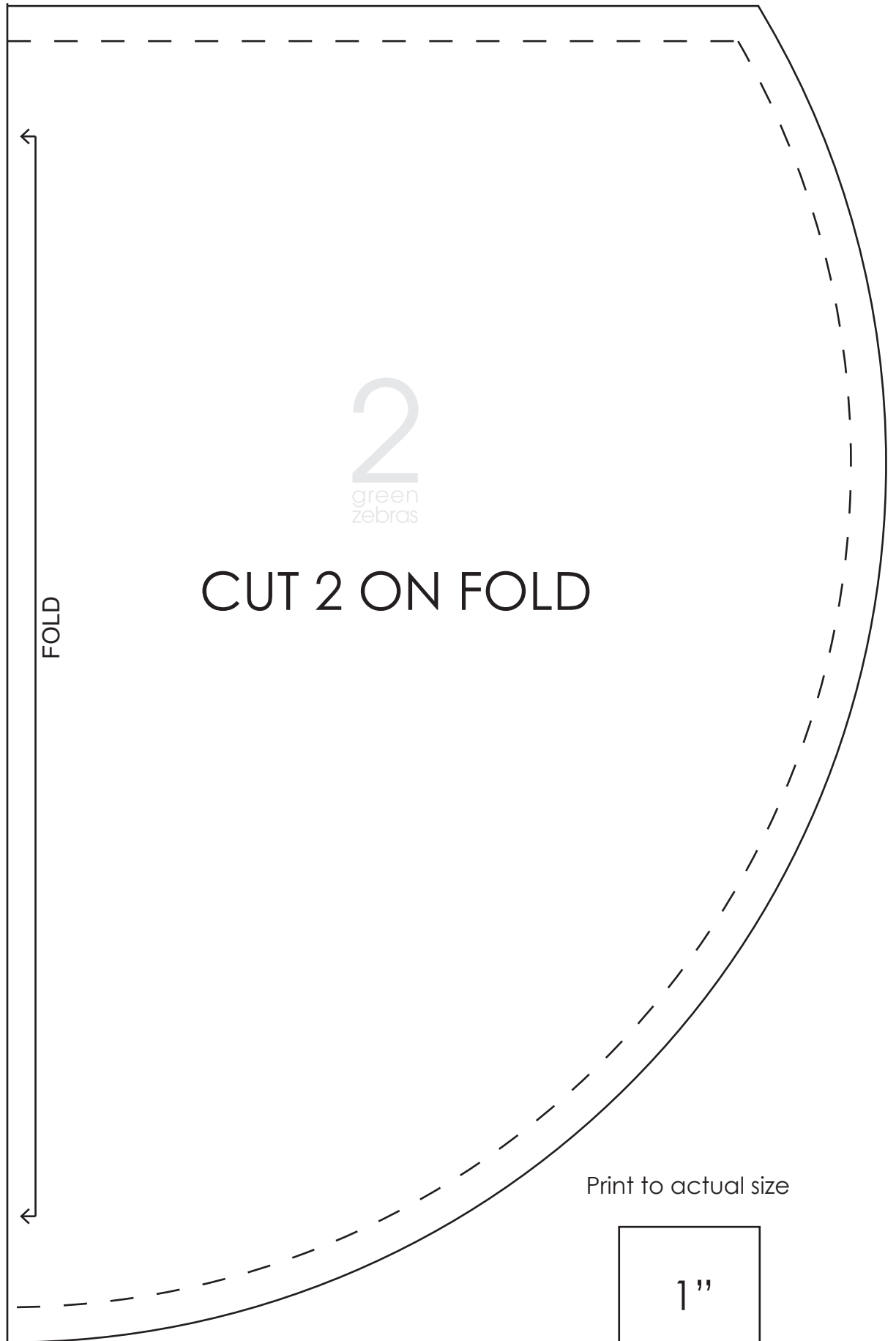

Print to actual size

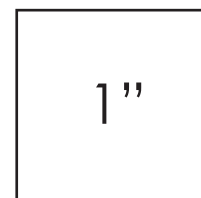

# PATTERN INSTRUCTIONS

**Use a 1/4" seam allowance throughout, unless otherwise stated.**

## MAKE THE RUFFLES AND STRAPS

Sew the ruffle strip short ends together with 1/4" seam allowance. Press seams open.

Fold ruffle strip right sides together and hem ends with 1/4" seam allowance. Then turn right side out and press corners. Sew 2 rows of basting stitch along the raw edge using longest stitch on your machine and leave threads either end for gathering.

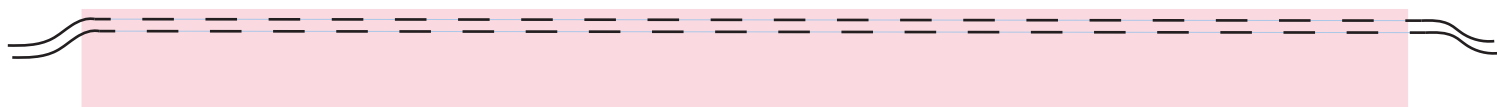

Pull bobbin threads to gather fabric until it is long enough to go around your bag piece.

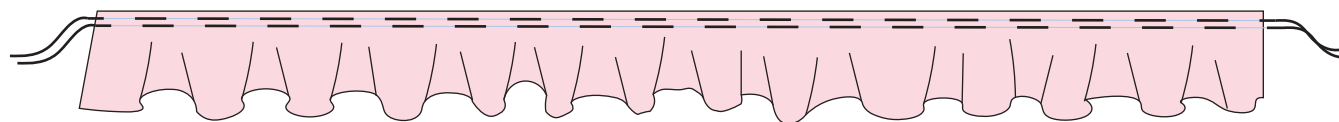

**Next take your remaining strips for the bag straps and ties.**

Add interfacing to the wrong side of your outer bag straps, then take your lining straps and place right sides together with your outer pieces. Sew along the long edges. Turn right side out and press. Top stitch along the long edges.



**OPTIONAL** Take your tie piece and fold long edges in towards the middle, then fold over again and press. Pin and sew all around the edges. Cut the finished strip in half to make 2 ties approx 10 inches long.

## QUILT OR STABILISE YOUR BAG

Add interfacing to the reverse side of your outer bag pieces. Quilt in your preferred way (optional). Trim excess wadding to size.

# PATTERN INSTRUCTIONS

Take one outer bag piece right side up and line your ruffle up edge to edge leaving 1/2" from the top of the bag and ends of the ruffle. Use quilt clips to secure while you take your remaining outer bag piece and lay on top face down.

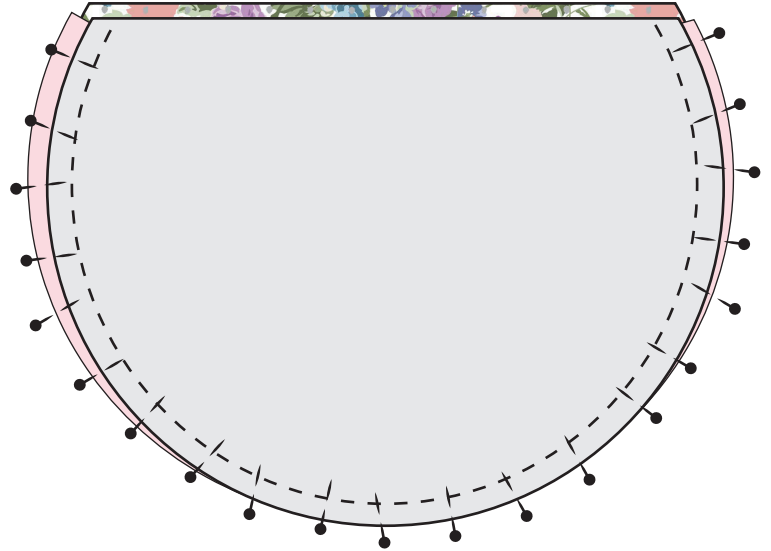
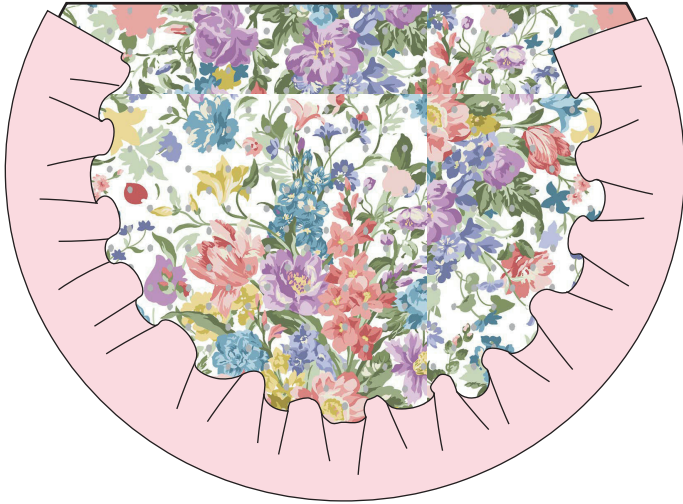

Pin in place using lots of pins to hold the layers together to secure while you sew. sew around the curved edge leaving the top edge open. You may wish to clip the edges to create ease in the curve once sewn.

Fold your bag piece in half lengthways and mark halfway between the edge and centre of the bag on both sides. This marks where your handles will go. Repeat for the back outer piece of your bag.

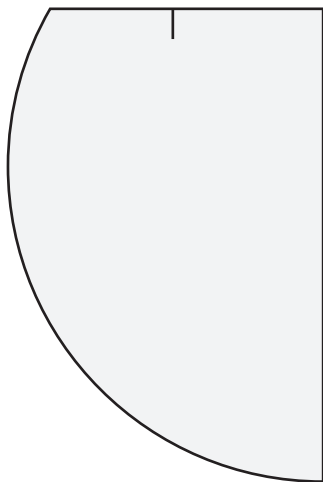

folded in half

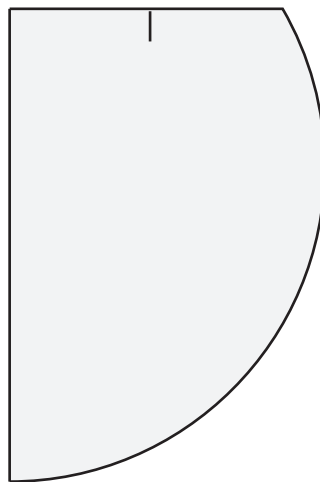

folded in half

# PATTERN INSTRUCTIONS

Turn your bag right side out and pin your straps to the front and back of the bag matching up your marks. Pin your tie strip (if using) to the centre front and back, with raw edges matching the top bag raw edge.



## POCKETS FOR LINING.

Take the two pocket lining pieces, fold in half lengthways with right sides together. Sew around the edges and base leaving the top raw edge open. Turn right side out and fold in the raw edge and sew to close the top.

Take your bag lining pieces and fold in half and press lightly to find the centre line. Pin your pocket pieces to the centre of each lining piece and sew in place following the sewn line on the pocket, leaving the top open. Press.

# PATTERN INSTRUCTIONS

Take your lining pieces and sew around the edge leaving a gap of approx 3" unsewn for turning, and leaving the top edge open.

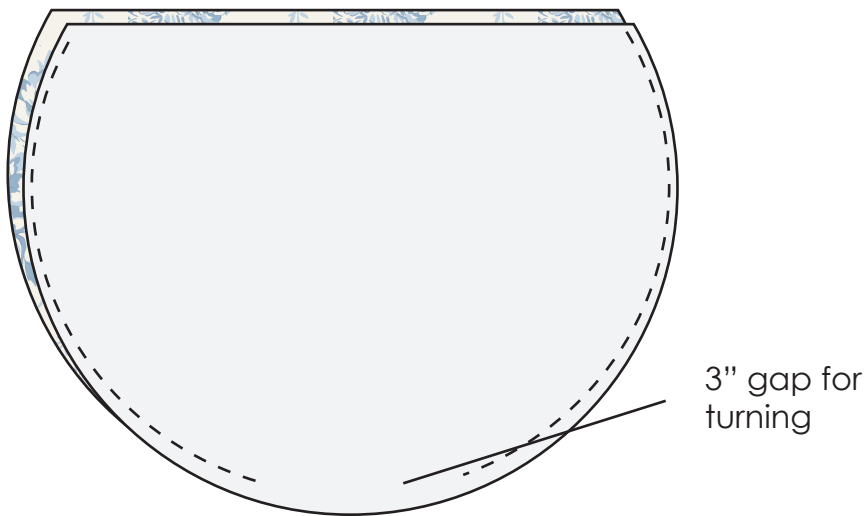

Place the outside of the bag inside the lining, right sides together, matching side seams. Make sure your straps are folded down inside between the layers. Pin and sew with a 1/2" seam allowance around the top edge of the bag to close. Trim off the excess seam allowance.

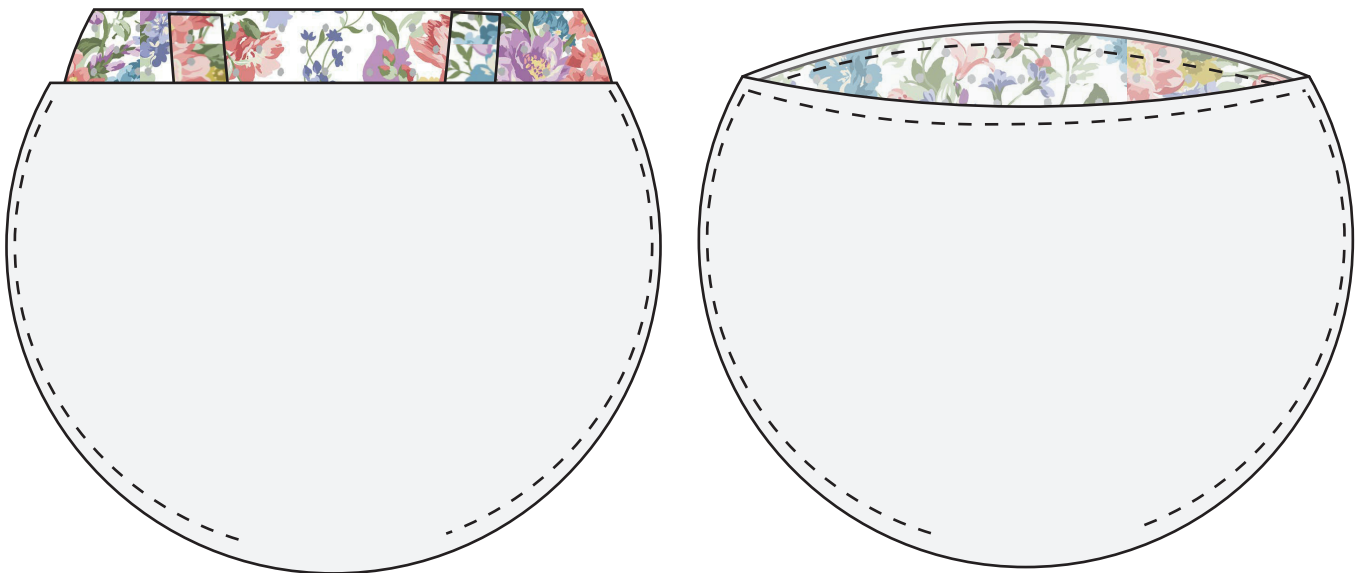

# PATTERN INSTRUCTIONS

Turn your bag right side out through the gap left in the lining. Press your bag. Sew a topstitch around the top of the bag and sew the gap in the lining closed and enjoy!



## OPTIONAL MATCHING ZIPPERED PURSE

With the remaining fabric pieces after making the bag, you can make a matching zippered purse. Follow the instructions in the QR code provided, and make according to your preferred size.



2  
green  
zebras

Two Green Zebras  
Worldwide Distributor of  
*Devonstone Collection*

[www.twogreenzebras.com](http://www.twogreenzebras.com)  
[sales@twogreenzebras.com](mailto:sales@twogreenzebras.com)  
[@2greenzebras](https://www.instagram.com/2greenzebras) [@devonstone\\_collection](https://www.instagram.com/devonstone_collection)

AUSTRALIAN DISTRIBUTOR  
**LIBERTY.**  
FABRICS