

SEWING
Planner

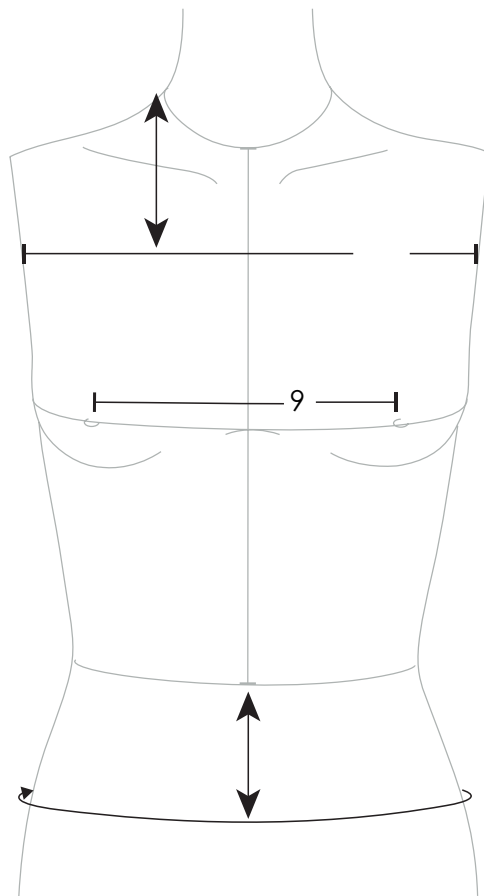

Two Green Zebras
Worldwide Distributor of
Devonstone Collection

www.twogreenzebras.com
sales@twogreenzebras.com
[@twogreenzebras](https://www.instagram.com/twogreenzebras) [@devonstone_collection](https://www.instagram.com/devonstone_collection)

DEVONSTONE
f a s h i o n

MY BODY Measurement

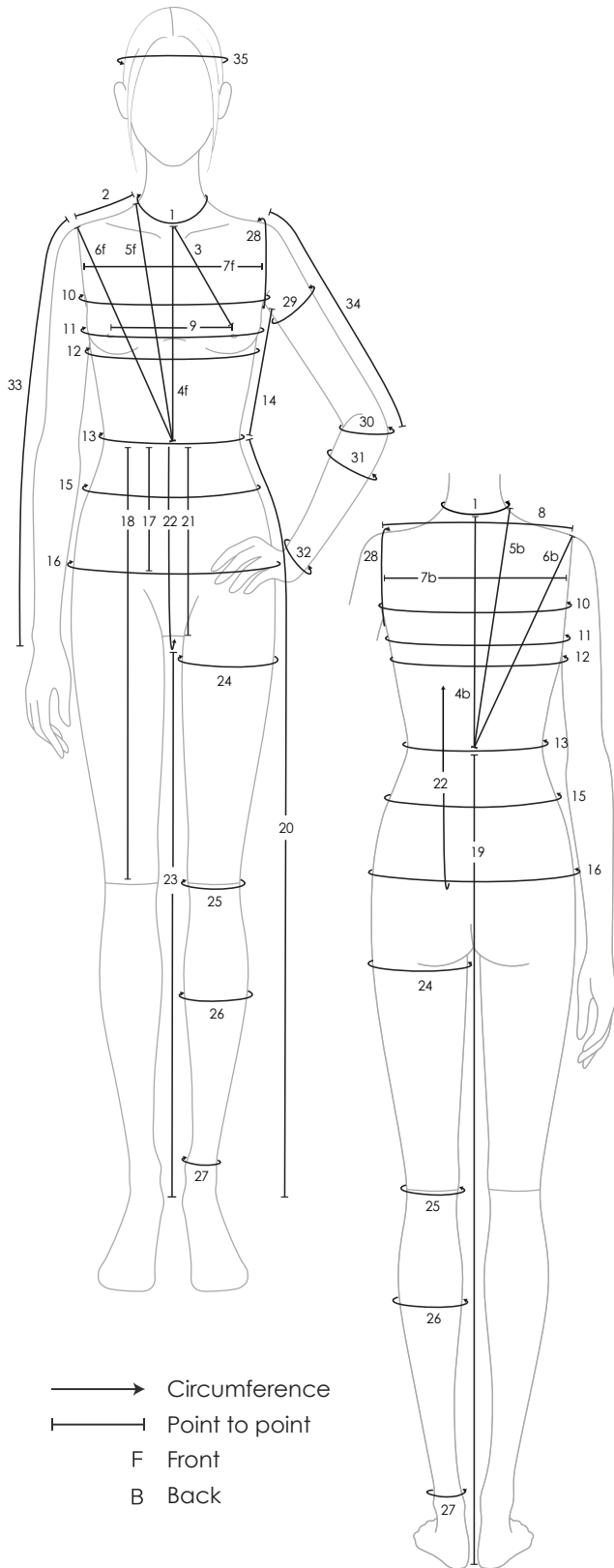

	ABOVE WAIST	Front	Back
1	Neck		
2	Shoulder Length		
3	Bust Length		
4	Waist Length		
5	HPS to Waist		
6	Shoulder Slope		
7	Across Chest		
8	Across Shoulder		
9	Apex to Apex		
10	Over Bust		
11	Bust		
12	Under Bust		
13	Waist		
14	Underarm to Waistline		
	BELOW WAIST		
15	Abdomen		
16	Hip		
17	Waist to Hip		
18	Waist to Knee		
19	Waist to Floor		
20	Side to Floor		
21	Crotch Depth		
22	Crotch Length		
23	Inseam		
24	Thigh		
25	Knee		
26	Calf		
27	Ankle		
	ARM		
28	Armscye		
29	Bicep		
30	Elbow		
31	Forearm		
32	Wrist		
33	Arm Length		
34	Elbow Length		
	OTHER		
35	Head Circumference		
36			
37			
38			
39			
40			
41			
42			

Measuring

GUIDE

CF / Center Front CB / Center Back HPS / Highest Point of the Shoulder on Neckline	TIPS / When measuring horizontally around the body, the measuring tape need to be parallel to the floor level. / When measuring vertically, the measuring tape need to be perpendicular to the floor.
---	--

ABOVE WAIST

1 Neck	Wrap tape lightly around the neck, measure above the collar bone
2 Shoulder Length	From the end of neck to the tip of shoulder
3 Bust Length	From neckline at CF to bust apex
4 Waist Length	On CF & CB, from neckline to waistline
5 HPS to Waist	Measure from HPS to waistline at CF/CB
6 Shoulder Slope	Measure left/right shoulder tip to waistline at CF/CB.
7 Across Chest	Measure 5" /13cm from HPS, take chest width from left to right armscye line
8 Across Shoulder	Lay tape on the back shoulder curve, measure from left to right shoulder tip
9 Apex to Apex	From bust apex to apex on bustline
10 Over Bust	Wrap tape comfortably under armpit, above bust
11 Bust	Measure the fullest part of the bust
12 Under Bust	Measure around the rib cage, right under the breast
13 Waist	Measure around the thinnest part of your waist
14 Underarm to Waistline	Measure along side seam, from armscye to waistline

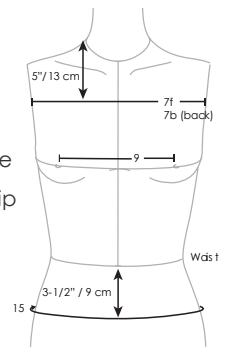

BELOW WAIST

15 Abdomen	On CF, measure 3-1/2" / 9cm from waistline, then measure around the body
16 Hip	Measure around the widest part of your hip
17 Waist to Hip	Measure distance from waistline to hipline at CF
18 Waist to Knee	Measure length from waistline to knee perpendicular to floor
19 Waist to Floor	Measure length from waistline to floor perpendicular to floor
20 Side to Floor	At side seam, lay tape onto body from waist to hip, and straight down to floor
21 Crotch Depth	Waistline to lowest part of the crotch
22 Crotch Length	Wrap comfortably along crotch, from front waistline to back waistline
23 Inseam	Measure from crotch to floor
24 Thigh	Measure around the thigh below the crotch, at the fullest point
25 Knee	Measure around the knee cap
26 Calf	Measure around mid-calf, at the fullest point
27 Ankle	Measure the narrowest part of the ankle

ARM

28 Armscye	Wrap from shoulder tip, and go underarm along the edge of bust & chest
29 Bicep	Wrap around the widest part of the upper arm, around 1" / 2.5cm from armpit
30 Elbow	Bend the arm then wrap around the elbow
31 Forearm	Wrap the fullest part of the forearm
32 Wrist	Measure the narrowest part of the wrist
33 Arm Length	Bend arm 45°, measure from shoulder tip, pass elbow and to wrist
34 Elbow Length	Bend arm 45°, measure from shoulder tip to the point of elbow

OTHER

35 Head Circumference	Wrap tape around the head at 1-2 fingers above eyebrows & the widest part of the head
-----------------------	---

MY GARMENT Measurement

TOP	LENGTH FROM HPS (HIGHEST POINT OF SHOULDER AT NECKLINE)			
ONE PIECE	LENGTH FROM HPS (HIGHEST POINT OF SHOULDER AT NECKLINE)			
BOTTOM	PANTS: INSEAM LENGTH / SKIRT: LENGTH FROM WAISTLINE			
SLEEVES	LENGTH FROM SHOULDER POINT			
PATTERN SIZE	PATTERN COMPANY	SIZE	PATTERN COMPANY	SIZE

Fill in the blank when you've found **THE PERFECT** length or sizes along the way.

OUTFIT Inspiration

SEASON /

COLOUR PALETTE

Primary Colours /

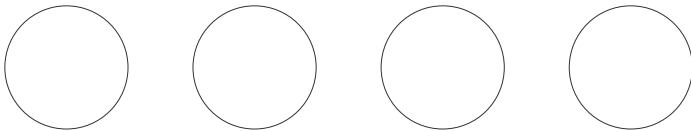

Accent Colours /

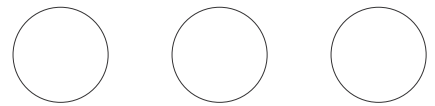

Outfit Style Descriptions

Step 1 / Copy & paste inspirational outfits photos above and observe the outfit styles & colours that you love.

Pattern / RECORD CARD

PATTERN DETAILS			NOTE / ADJUSTMENTS		
Name					
Pattern From					
Size Range	Code				
Cut Size	Difficulty ☆☆☆☆☆				
Pattern for Woven Fabric Stretch Fabric					
SEAM ALLOWANCE			DESIGN STYLE		
General	Neck				
Armhole					
Bottom Hem					
CUT LIST					
		Qty			
01					
02					
03					
04					
05					
06					
07					
08					
09					
10					
11					
12					
13					
14					
15					
16					
FABRICS NEEDED	Width	Qty	NOTION NEEDED	Size	Qty
01			01		
02			02		
03			03		
04			04		
05			05		
06			06		
07			07		
08			08		

Fabric Swatch / BOOK

FABRIC TYPE /

WOVEN STRETCH

#	Fabric Name	Inventory
SWATCH	Weight	<input type="text"/>
	Width	Laundry Care
	Purchased At	<input type="checkbox"/> <input type="checkbox"/> <input type="checkbox"/> <input type="checkbox"/> <input type="checkbox"/> <input type="checkbox"/> <input type="checkbox"/>
	Price	Prewashed <input type="radio"/> Yes <input type="radio"/> No
	Date purchased	Matching Thread <input type="radio"/> Yes <input type="radio"/> No
	Name	Note
	Content	
#	Fabric Name	Inventory
SWATCH	Weight	<input type="text"/>
	Width	Laundry Care
	Purchased At	<input type="checkbox"/> <input type="checkbox"/> <input type="checkbox"/> <input type="checkbox"/> <input type="checkbox"/> <input type="checkbox"/> <input type="checkbox"/>
	Price	Prewashed <input type="radio"/> Yes <input type="radio"/> No
	Date purchased	Matching Thread <input type="radio"/> Yes <input type="radio"/> No
	Name	Note
	Content	
#	Fabric Name	Inventory
SWATCH	Weight	<input type="text"/>
	Width	Laundry Care
	Purchased At	<input type="checkbox"/> <input type="checkbox"/> <input type="checkbox"/> <input type="checkbox"/> <input type="checkbox"/> <input type="checkbox"/> <input type="checkbox"/>
	Price	Prewashed <input type="radio"/> Yes <input type="radio"/> No
	Date purchased	Matching Thread <input type="radio"/> Yes <input type="radio"/> No
	Name	Note
	Content	
#	Fabric Name	Inventory
SWATCH	Weight	<input type="text"/>
	Width	Laundry Care
	Purchased At	<input type="checkbox"/> <input type="checkbox"/> <input type="checkbox"/> <input type="checkbox"/> <input type="checkbox"/> <input type="checkbox"/> <input type="checkbox"/>
	Price	Prewashed <input type="radio"/> Yes <input type="radio"/> No
	Date purchased	Matching Thread <input type="radio"/> Yes <input type="radio"/> No
	Name	Note
	Content	

Fabric Swatch / CARD

#	#	#	#
Content	Content	Content	Content
Fabric Name	Fabric Name	Fabric Name	Fabric Name
Weight	Weight	Weight	Weight
Purchased At	Purchased At	Purchased At	Purchased At
Date	Date	Date	Date
Price	Price	Price	Price
#	#	#	#
Content	Content	Content	Content
Fabric Name	Fabric Name	Fabric Name	Fabric Name
Weight	Weight	Weight	Weight
Purchased At	Purchased At	Purchased At	Purchased At
Date	Date	Date	Date
Price	Price	Price	Price
#	#	#	#
Content	Content	Content	Content
Fabric Name	Fabric Name	Fabric Name	Fabric Name
Weight	Weight	Weight	Weight
Purchased At	Purchased At	Purchased At	Purchased At
Date	Date	Date	Date
Price	Price	Price	Price
#	#	#	#

SWAY
CH

SWAY
CH

SWAY
CH

SWAY
CH

SWAY
CH

SWAY
CH

SWAY
CH

SWAY
CH

CUT HERE







CUT HERE







CUT HERE







Create swatch card at the same time as it's easier to bring out on a sourcing trip.







DEVONSTONE
f a s h i o n







Fabric / LABEL







#	Content		Inventory					
	Fabric Type		Laundry Care 					
	Weight	Width	Prewashed			<input type="radio"/> Yes	<input type="radio"/> No	
	Purchased At		Matching Thread			<input type="radio"/> Yes	<input type="radio"/> No	
	Price	Date	Note					







#	Content		Inventory					
	Fabric Type		Laundry Care 					
	Weight	Width	Prewashed			<input type="radio"/> Yes	<input type="radio"/> No	
	Purchased At		Matching Thread			<input type="radio"/> Yes	<input type="radio"/> No	
	Price	Date	Note					







#	Content		Inventory					
	Fabric Type		Laundry Care 					
	Weight	Width	Prewashed			<input type="radio"/> Yes	<input type="radio"/> No	
	Purchased At		Matching Thread			<input type="radio"/> Yes	<input type="radio"/> No	
	Price	Date	Note					

#	Content		Inventory					
	Fabric Type		Laundry Care 					
	Weight	Width	Prewashed			<input type="radio"/> Yes	<input type="radio"/> No	
	Purchased At		Matching Thread			<input type="radio"/> Yes	<input type="radio"/> No	
	Price	Date	Note					

#	Content		Inventory					
	Fabric Type		Laundry Care 					
	Weight	Width	Prewashed			<input type="radio"/> Yes	<input type="radio"/> No	
	Purchased At		Matching Thread			<input type="radio"/> Yes	<input type="radio"/> No	
	Price	Date	Note					

#	Content		Inventory					
	Fabric Type		Laundry Care 					
	Weight	Width	Prewashed			<input type="radio"/> Yes	<input type="radio"/> No	
	Purchased At		Matching Thread			<input type="radio"/> Yes	<input type="radio"/> No	
	Price	Date	Note					

#	Content		Inventory					
	Fabric Type		Laundry Care 					
	Weight	Width	Prewashed			<input type="radio"/> Yes	<input type="radio"/> No	
	Purchased At		Matching Thread			<input type="radio"/> Yes	<input type="radio"/> No	
	Price	Date	Note					

#	Content		Inventory					
	Fabric Type		Laundry Care 					
	Weight	Width	Prewashed			<input type="radio"/> Yes	<input type="radio"/> No	
	Purchased At		Matching Thread			<input type="radio"/> Yes	<input type="radio"/> No	
	Price	Date	Note					

Print on sticker paper & paste on any fabrics to record important details.